



## PSQN – Dell UPS Management Software

### Contents:

- [Scenario 1](#): Single UPS, multiple servers, USB or RS232 local connection
- [Scenario 2](#): Single UPS, multiple servers, Network Management Card connection
- [Scenario 3](#): Multiple redundant UPS, multiple servers with redundant power supplies
- [Messaging and Email Alerts](#)

### Assumptions:

**Network:** All servers should be connected to the same LAN.

**Firewalls:** Provision should be taken to ensure that firewalls are not blocking communication of the Dell software agents between networked servers. The ports required by the software and network card (if appropriate) are as follows. UDP: 2198, 2199, 2200, 161(NMC), 162(NMC), 3369(NMC), TCP: 2099.

**Software versions:** The user should be using the very latest software version before continuing with this guide. For more information go to <http://support.us.dell.com/support/downloads/> or equivalent country page, search by Dell UPS Management Software.

**Operating Systems:** This guide is written primarily for Windows operating systems. For installation on other operating systems please refer to full Dell UPS Software Users Guide.



**Scenario 1:**

- Server 1 is powered by a single UPS and is connected by USB.
- Server 2, 3 and 4 are also powered by the UPS.
- Server 2, 3 and 4 monitor Server 1's agent for notification of events and shutdown.
- Network Management card is not installed.

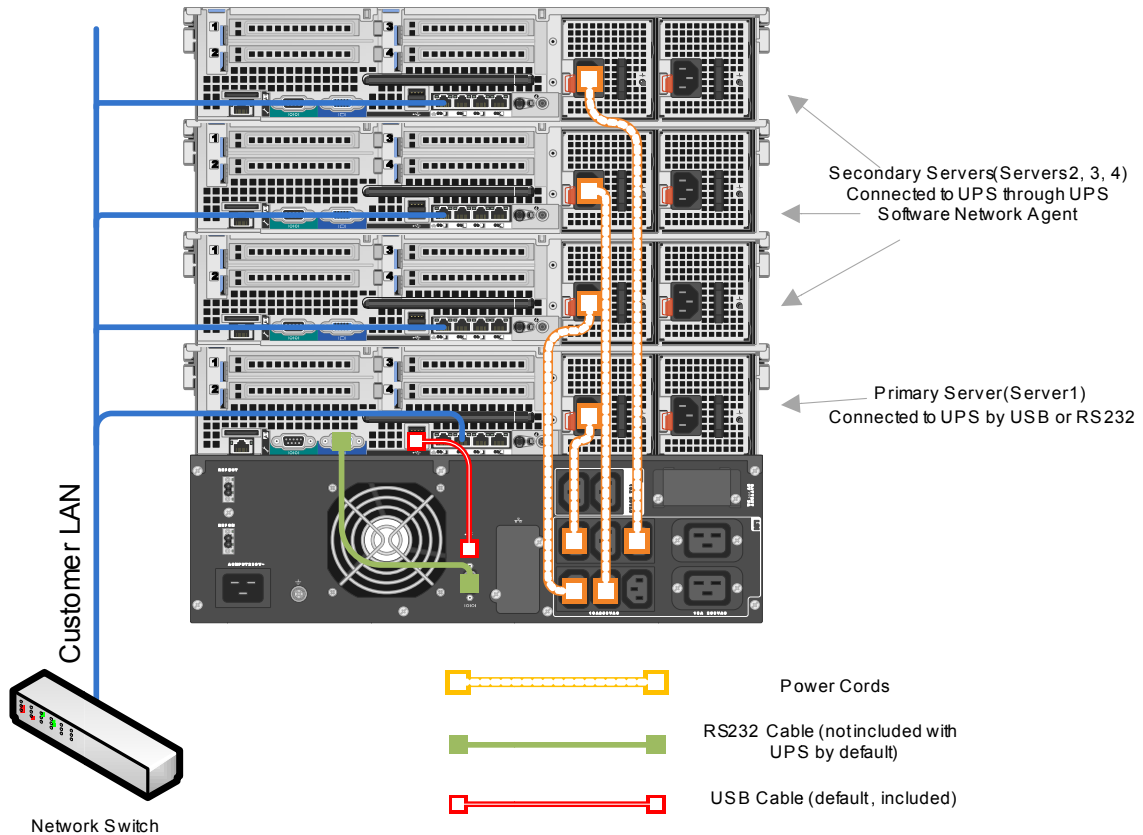

**Connectivity diagram for Dell UPS with USB or RS232 connection to four Dell servers.**  
 Power cables are for illustrative purposes only. For best practice refer to Dell UPS Cabling Guide,

**Connectivity:**

Connect the Dell UPS to a server via either the USB cable (supplied) or DB-9 RS232 cable (customer purchase option). DB-9 pin-out configuration, pin # (use), 2 Tx (out from UPS), 3 Rx (in to UPS), 5 ground, 1, 4, 6, 7, 8, 9 unused).



The server to which you make this connection is called the “primary” server. All other servers are “secondary” servers and are assumed to be on the same customer LAN.



**Quick Start Summary:**

**Shutdown parameters managed from a primary server, all others as secondary.**

Install the Dell UPS Management software on all the servers. On the primary server the UPS will be discovered by Auto Search. To configure shutdown settings, first click on the primary server name in the network tree diagram and then configure required shutdown parameters. Add secondary servers in the Shutdown Conditions options box by entering their IP address. On the secondary servers, click on the server you want to configure in the network tree diagram and then in the shutdown parameters configuration, choose “Remote Shutdown by Agent”. Enter the IP address of the primary server to create a 2-way link between the software agents. The software agent on the primary server will broadcast shutdown commands to the secondary servers in the event of a power failure.

**Detailed Installation Guide**

**Software Installation for primary server:**

Install the Dell UPS Management software on the primary server. Get the latest version of the software from support.dell.com :

- Drivers & Downloads ➤ Choose model ➤ Choose R710 server or similar ➤ System Firmware ➤ Dell CD ISO Image

Once installation of the software is complete, add the UPS to the management console:

1. Act as administrator (default password is to leave the cell empty, just press OK). Note that if at any time using this software your options are grayed out, use “Act as administrator” to restore your credentials.
2. Choose System ➤ Auto Search UPS (later versions of the software will automatically search for connected UPSs).

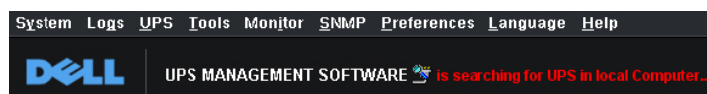

The software looks for UPSs attached to the primary server

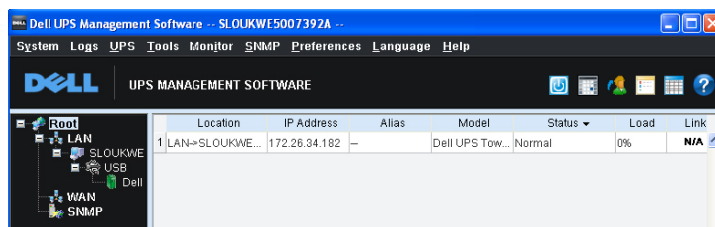

And then when it finds the UPS it is shown in the “LAN” tree diagram under LAN -> PC Name -> Port Name (USB/COM1 ) -> UPS Name

3. Click on the green Dell UPS Icon to see the power metrics.

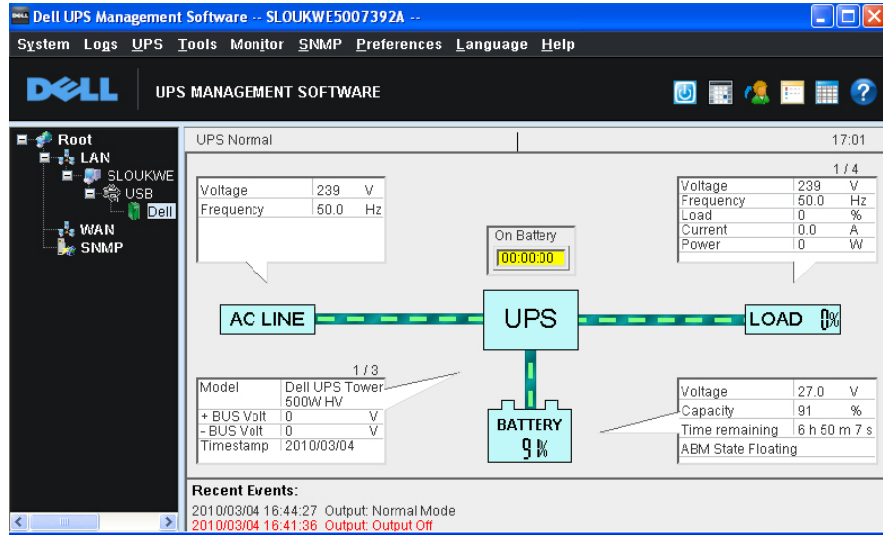

4. To configure server shutdown settings click on the primary server ID in the network tree diagram (SLOUKWE in this example).
5. Edit the shutdown parameters: Menu **UPS** **Shutdown Parameter**.

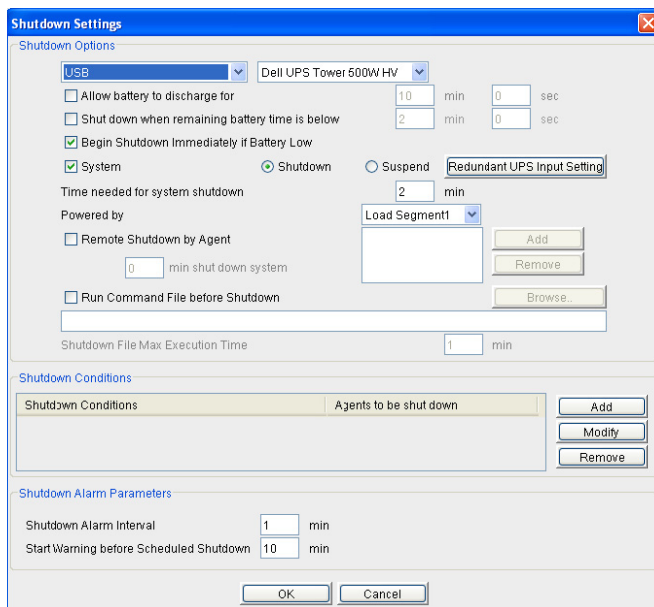

- a. Ensure the correct connection method (USB or RS232) is selected in the first menu list.
- b. Choose your shutdown settings. Available options:
  - i. *Allow battery to discharge for:* the software begins shutdown of servers after x mins on battery.
  - ii. *Shut down when remaining battery time is below:* the software begins the shutdown of servers x mins before the UPS battery runs out. Note you should allow ample time for servers to shut down safely.



- iii. *Begin shutdown immediately if battery low:* keep this option checked. Should the UPS return to service after a power failure and have low battery, a subsequent power failure would leave the UPS with little battery power and require immediate shutdown of servers. To configure the UPS to restart when a minimum charge has been gained, refer to Load Segment Control.
- iv. *System: Shutdown/Suspend.* Choose Shutdown unless you have a Windows system which you would like to suspend (hibernate) instead of shut down.
- v. *Time needed for system shutdown:* this is the approximate time required for the server to complete the shutdown process. The software uses this time to calculate a safe duration from requesting a system shutdown to when the server will be safely shut down before powering off the UPS output power sockets.
- vi. *Remote shutdown by agent:* when running this software on secondary servers check this box and choose “Add”. Enter the IP address of the primary server. The primary server will server as the controller while the secondary server will function as a group member.
- vii. *Run command file before shutdown:* optional batch file or exe file processing before system shutdown commences.
- viii. *Shutdown conditions:* add each secondary server IP addresses to this list: Add ➔ IP address of server. This tells the UPS agent where to broadcast shutdown and control messages.

NOTE: Configurations made in this menu are “OR” commands, meaning that whichever event happens first will cause an action. If timings are in conflict (e.g. shutdown 20mins after power failure, but shutdown immediately when battery low (and battery IS low), the software will begin a shutdown immediately. This is designed so that a server doesn’t wait for 20minutes to shut down even though there is no battery power remaining.

**Installing the software on the secondary servers:**

Install the Dell UPS Management Software on all secondary servers. UPS Auto Search will fail to find a directly attached Dell UPS – this is normal.

1. To configure server shutdown settings click on the secondary server ID in the network tree diagram (SLOUKWE in this example).
2. Access UPS Shutdown Parameters: Menu ➔ UPS ➔ Shutdown Parameter.
3. Choose “remote shutdown by agent” ➔ Add ➔ Enter IP address of primary server. General shutdown parameters do not need to be configured here (they are already configured on the primary server). The only variables to configure here are:
  - a. Check the “System” box to request system shutdown in the event of power failure. Options for Windows platforms are shutdown or suspend (hibernate).
  - b. Enter the “Time needed for system shutdown” which is the time required for the secondary server to perform its shutdown process. Be generous with this setting (e.g Time+3 minutes).

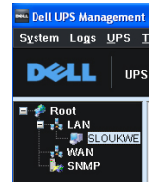



**Linking the Agents:**

In order to create a secure link between both primary and secondary server software Agents:

*Primary Server:*

Add the secondary server agent information in the Shutdown Conditions box: Menu ➤ Shutdown Parameter ➤ Shutdown Conditions ➤ Add. Enter the IP address(es) of the secondary servers running the Dell UPS Management Software.

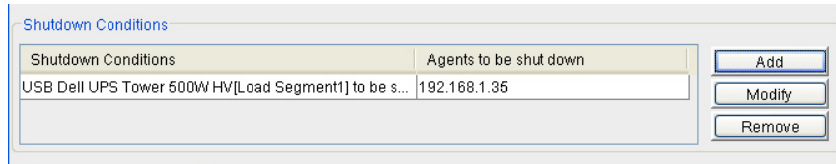

*Secondary Server:*

Menu ➤ Shutdown Parameter ➤ Shutdown Conditions : Check the “System” box, then “Remote Shutdown by Agent”. Then “Add” to enter the IP address of the primary server (192.168.1.35 in this example).

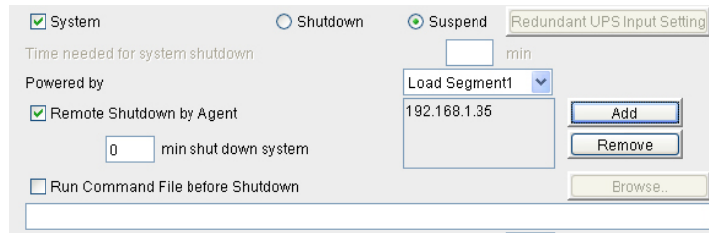

***Your installation is complete. To test the system, remove the input power from the Dell UPS and wait until the pre-configured time options elapse. Confirm systems shutdown visually and through event logs. Note this will cause a shutdown of servers and so should only be carried out when the servers are not in live service!***



## Scenario 2

- Server 1 is powered by a single UPS.
- Server 2, 3 and 4 are also powered by the same UPS.
- Server 2, 3 and 4 monitor the UPS for notification of events and shutdown.
- Network Management card is installed.

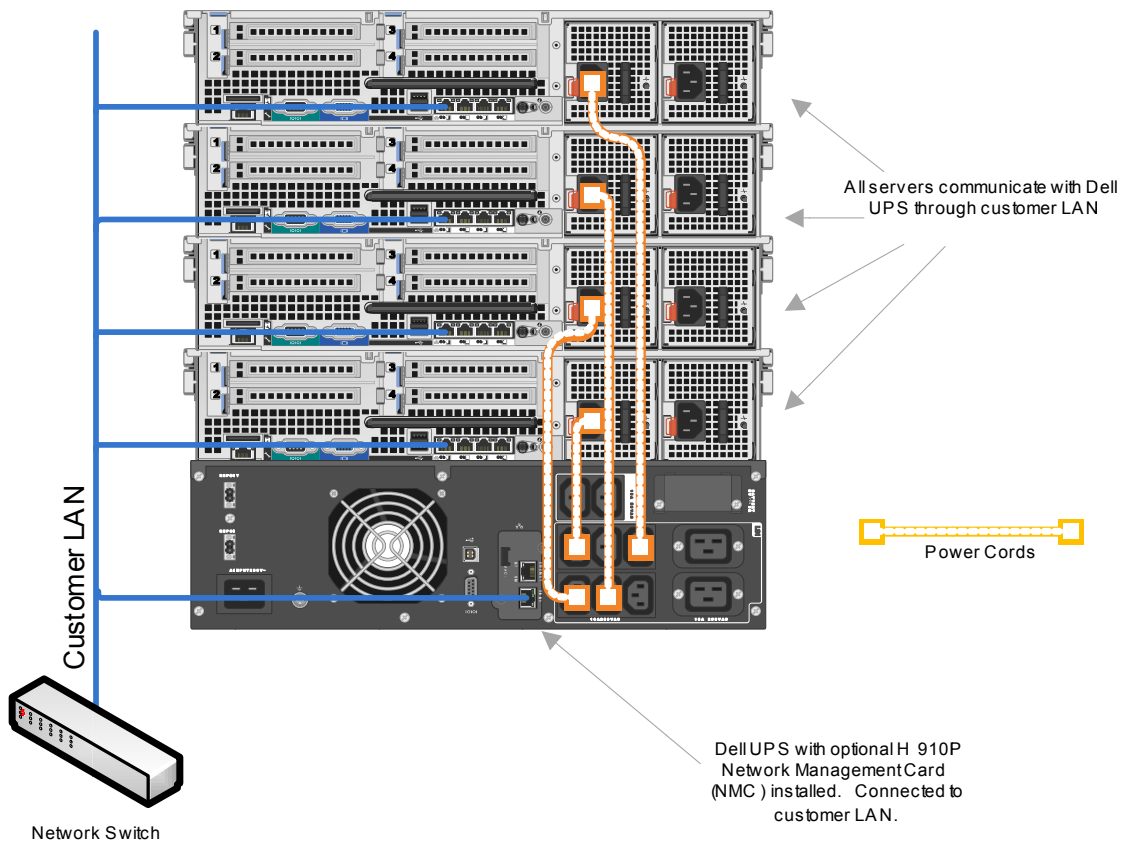

**Connectivity diagram for Dell UPS with optional Network Management Card<sup>1</sup> and four Dell Servers. Power cables are for illustrative purposes only. For best practice refer to Dell UPS Cabling Guide.**

### Connectivity:

Connect the Dell UPS Network Management Card (NMC) to the customer network through a standard Ethernet cable. The NMC ships with SNMP disabled by default, so this must be enabled through the access control menu before proceeding. All other servers should be connected to the same LAN. The LAN must support SNMP v1 (early

<sup>1</sup> Dell part number for NMC Card H910P varies by region.





card revisions) or v2 (later card revisions) – so enable the SNMP services on the server(s) and set the community string (public is default on network card).

## Quick Start Summary:

### All servers communicate directly with the Dell UPS Network Management Card.

Enter the NMC settings through a web browser ([http://\[IP ADDRESS\]](http://[IP ADDRESS])). The default username and password is 'admin', 'admin'. SNMP functionality of the NMC is disabled by default, so enable this in the Access Control menu. Configure the shutdown parameters directly on the NMC. The NMC is read-only so changes can only be made through this web interface.

Install the Dell UPS Management Software on all servers. Add the UPS to the software through Menu  SNMP  Search Device. Input the IP address of the NMC. The Dell UPS will be added in the SNMP tree menu. Click on the Dell UPS to see parameters. For each server (click on current server in network tree view first) set the following parameters in the Shutdown Parameters menu:

- Select the correct input from the drop down box (SNMP, and ensure IP address is correct)
- Check the "system" box to enable system shutdown
- Enter "Time needed for system shutdown"

When power failure occurs, the NMC will send SNMP signals to the Dell UPS software in accordance with the parameters configured on the NMC and the appropriate course of action will be taken.

## Detailed Installation Guide

### Configuring the Network Management Card

Refer to the quick start guide provided with the NMC in order to provide IP address and other network settings. The card is DHCP enabled by default so you should change this to a static IP address once you have access the configurations page.

1. Access the NMC control menu through a web browser. Input the address of <http://> followed by the IP address of the NMC and use the default passwords of Username: admin, Password: admin.



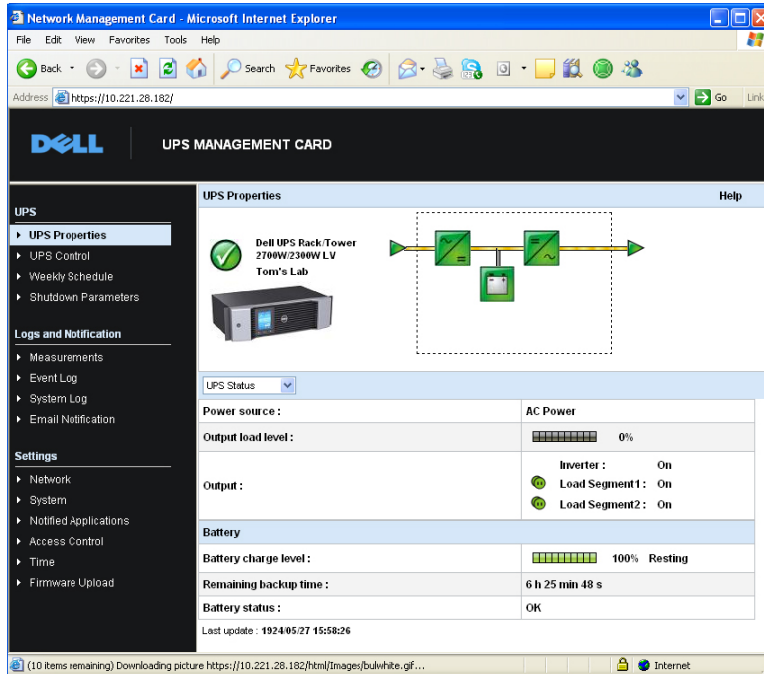

2. Enable SNMP through the Menu **Access Control** **SNMP**. You will be prompted to restart the NMC for changes to take effect. To do this, click the hyperlink at the top of the page, or visit Menu **System** **Reset Communication**. Note that the “Reset Communication” button is close to the “Factory Reset” button.
3. Edit the shutdown parameters that you want to take effect in the event of a power failure: Menu **Shutdown Parameters**. Click on “Show advanced Parameters” to show all shutdown settings.
4. Refer to the NMC manual for full information on the control parameters, but follows a summary of key points:
  - a. *Inverter*: refers to the overall UPS controls.
  - b. *Load Segments 1 & 2*: refer to the different banks of sockets on the rear of the UPS which can be controlled independently of each other (for example to shut down non essential systems early and save battery for essential systems, or to start some servers before others when power returns).
    - i. *Shutdown if remaining time under*: send shutdown command when battery has x seconds remaining.
    - ii. *Shutdown if capacity under*: as above, but expressed as a percent of battery power.
    - iii. *After x min*: initiate the shutdown process after x seconds on battery.
    - iv. *Shutdown duration*: time required for servers to safely shutdown before UPS turns the output sockets off.
    - v. *Restart if capacity exceeds*: forces the UPS to wait until batteries achieve x% charge level before applying power to the output sockets and allowing servers to restart.

NOTE: Configurations made in this menu are “OR” commands, meaning that whichever event happens first will cause an action. If timings are in conflict (e.g. shutdown 20mins after power failure, but shutdown immediately when battery low (and battery IS low)), the software will begin a shutdown immediately. This is designed so that a server doesn’t wait for 20minutes to shut down even though there is no battery power remaining.

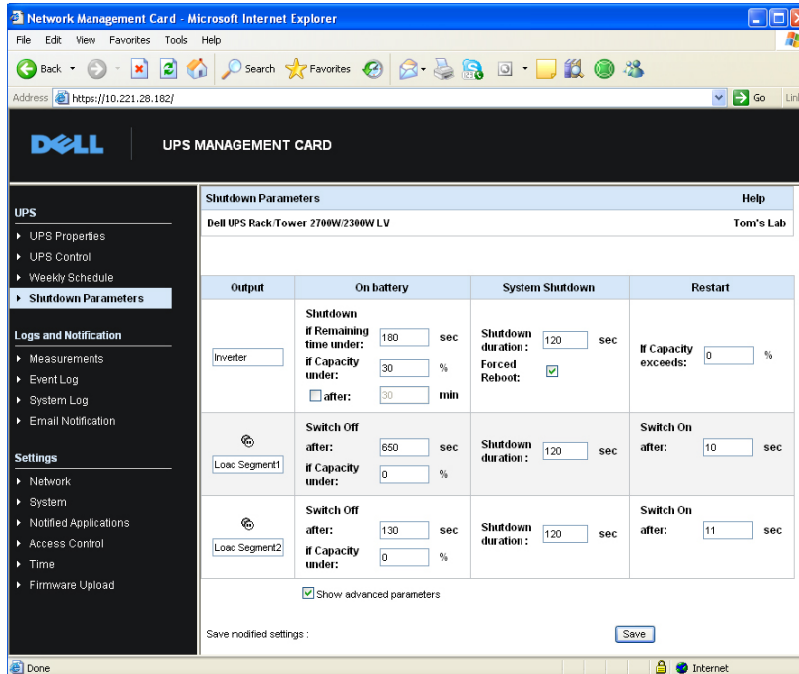

Shutdown parameter window of Network Management Card

**Software Installation:**

Install the Dell UPS Management software on all servers. Get the latest version of the software from support.dell.com :

- ➔ Drivers & Downloads ➔ Choose model ➔ Choose R710 server or similar ➔ System Firmware ➔ Dell CD ISO Image

Once installation of the software is complete, add the UPS to the management console:

1. Click on the SNMP tree item, then Act as administrator (default password is to leave the cell empty, just press OK). Note that if at any time using this software your options are grayed out, use “Act as administrator” to restore your credentials.
2. Add the UPS to the software: Menu ➔ SNMP ➔ Search Device. Enter the IP address of the NMC.
3. Click on the Dell UPS under the SNMP tree menu to see the UPS parameters.

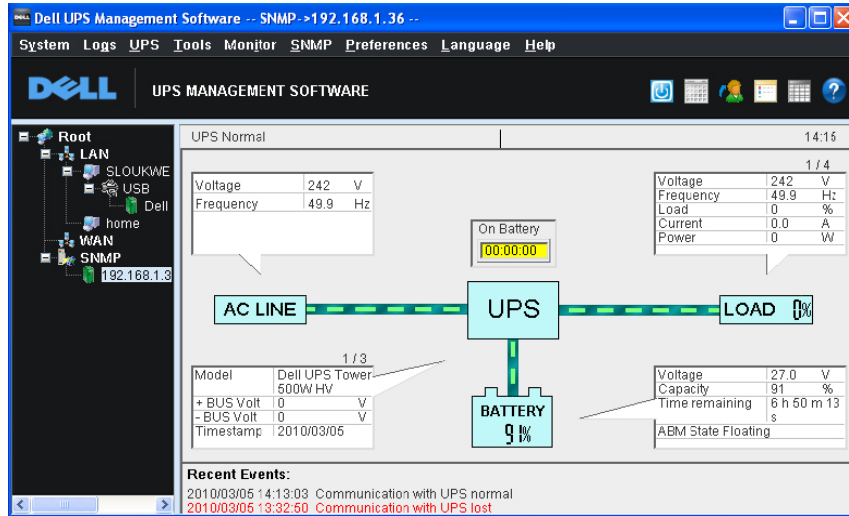

4. To configure the shutdown settings, first click on the server you are configuring in the network tree diagram (SLOUKWE in this example), then: Menu → UPS → Shutdown parameters. Choose SNMP from the drop down box and confirm this is the correct IP address in the next box. The settings on the NMC prevail over the default values in the software so the only changes required are:
  - a. Select the correct input from the drop down box (SNMP, and ensure IP address is correct)
  - b. Check the “system” box to enable system shutdown
  - c. Enter “Time needed for system shutdown”

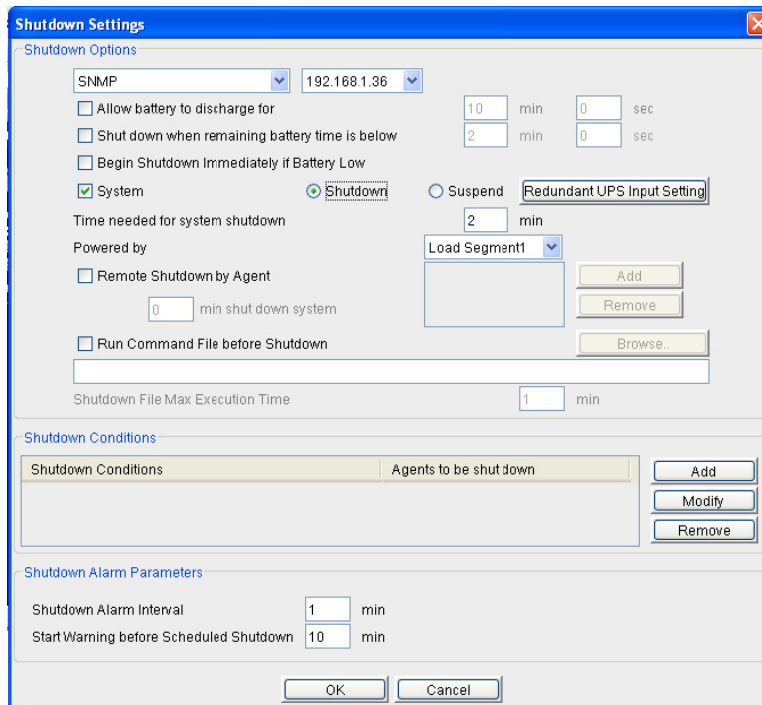

5. Repeat the above steps for each server.

**Mass configurations:**

Latest versions of the Dell UPS Management software supports silent installation and mass configuration push across the network. This removes the need to install the client and create settings manually on each server. Refer to the specific documentation of these features for full support.

*Your installation is complete. To test the system, remove the input power from the Dell UPS and wait until the pre-configured time options elapse. Confirm systems shutdown visually and through event logs. **Note this will cause a shutdown of servers and so should only be carried out when the servers are not in live service!***



### Scenario 3

- Server 1 is powered by UPS 1 and UPS 2. Server is connected by USB to UPS 1.
- Server 2 is powered by UPS 1 and UPS2. Server is connected by USB to UPS 2.
- Server 3 connects to UPS 1, Server 4 is connected to UPS 2.

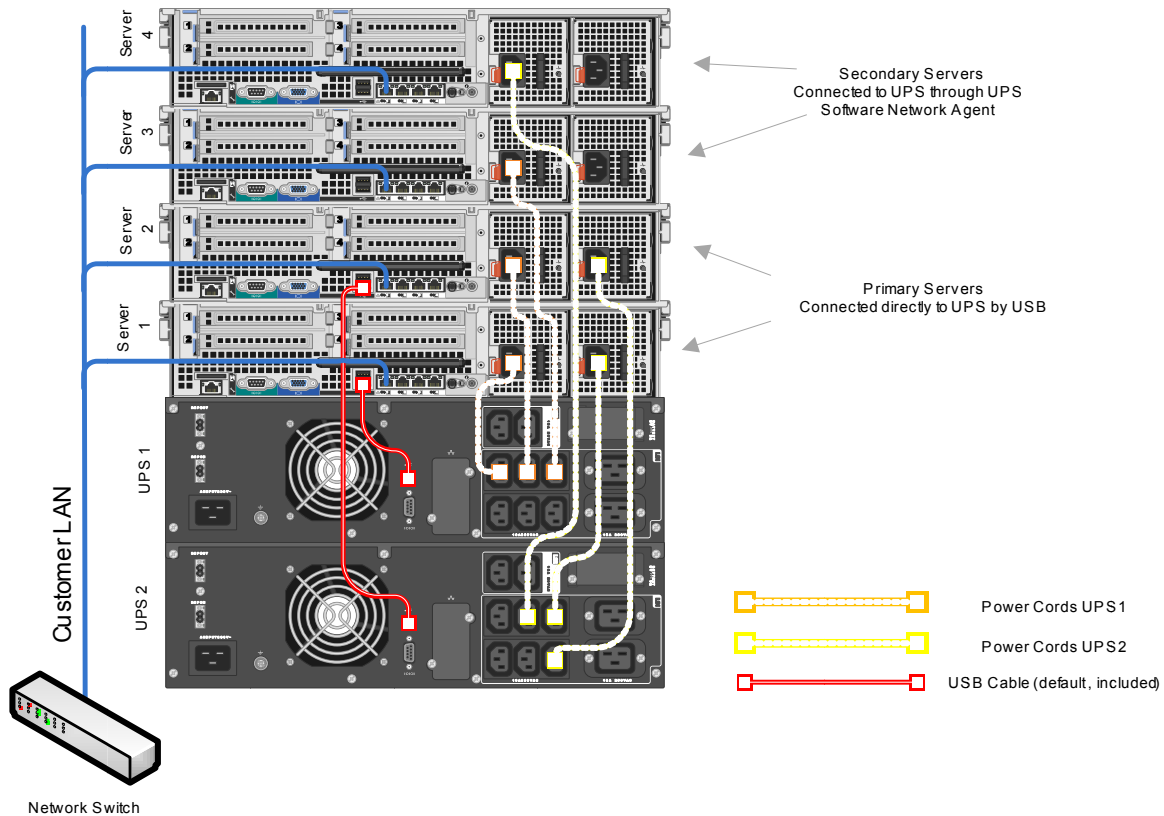

**Connectivity diagram for redundant Dell UPS configuration and four Dell Servers.**  
**Power cables are for illustrative purposes only. For best practice refer to Dell UPS Cabling Guide.**

### Connectivity:

Connect the Dell UPS 1 to server 1 using the supplied USB cable. Connect the Dell UPS 2 to server 2 using the supplied USB cable. All servers are connected to the customer LAN. Servers 1 and 2 are powered by both UPS 1 & 2 and so are considered to be running in “redundant” configuration. Server 3 is powered by UPS 1 only. Server 4 is powered by UPS 2 only. Servers 3 & 4 are operating in non-redundant power configuration.



### Quick Start Summary:

#### Servers 1 & 2: Managing shutdown conditions with a redundant UPS supply.

Install the Dell UPS Management software on servers 1 and 2. Configure shutdown parameters on the servers in keeping with installation notes for scenario 1 for primary servers. Ensure that both UPS 1 and UPS 2 are visible on each of server 1 & 2 through the LAN or WAN tree items. Now in the shutdown parameters for each software installation, click on the “Redundant UPS” Input Setting box and select both UPS 1 and UPS 2 from the menu. The shutdown settings you apply will now account for the status of both UPS 1 and UPS 2. In neither case do you need to enable “Remote Shutdown by Agent” as each of Server 1 & 2 are directly connected to a UPS.

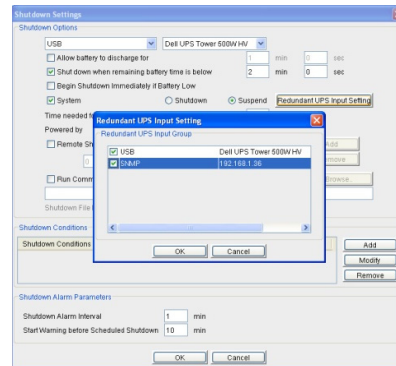

#### Servers 3 & 4: Managing shutdown conditions from a remote UPS.

Install the Dell UPS Management software on servers 3 & 4. Configure shutdown parameters on the servers in keeping with installation notes for scenario 1 on secondary servers. Ensure that when choosing “Shutdown by remote agent” option that the correct Agent is selected to ensure the correct messaging (i.e. UPS 1 to server 3 and UPS 2 to server 4).

### Messaging & Email Alerts

To provide messaging to servers of your choice, access the broadcast settings (Tools ➔ Broadcast Settings). Add all servers’ IP addresses that you want to broadcast messages to and then select which events you would like to broadcast. Note that the more events you select, the more messages will be sent. This service uses Microsoft Messaging Service so ensure that you start this service to use the broadcast feature.

To provide email alerts on power events, access the configuration menu: Tools ➔ Email Settings and provide the relevant SMTP information. Add the recipient(s) email address(es) and select which events to send via email. For more detailed explanation of email settings refer to the Dell UPS Software Users Guide.

